

FIGURES FOR CHAPTER 6

**DYNAMIC NEURAL NETWORKS AND THEIR APPLICATIONS TO CONTROL
AND CHAOS PREDICTION**

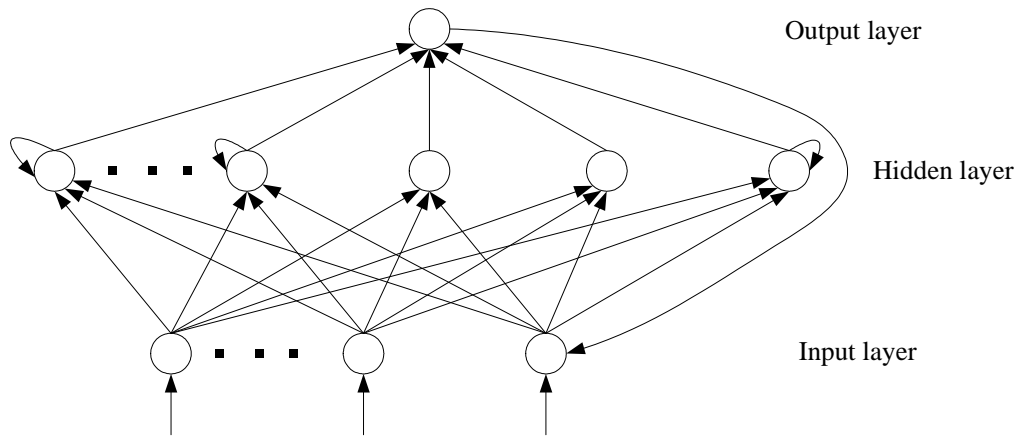

Figure 6.1. A typical structure of recurrent network

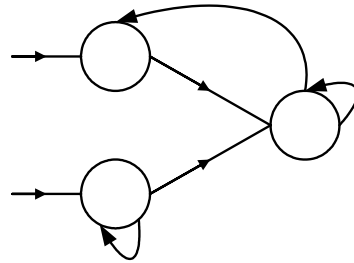

Figure 6.2. Feedback signals among neurons of RNN

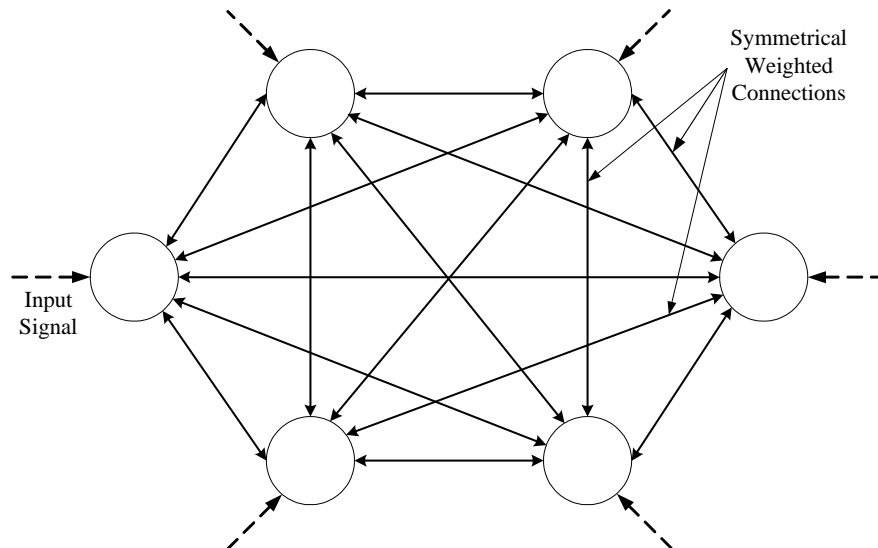

Figure 6.3: Typical representation of the Hopfield Neural network

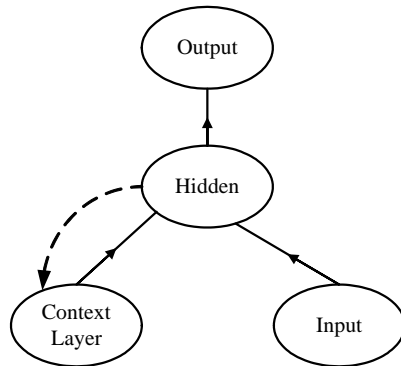

Figure 6.4. Architecture of a simple recurrent network (Elman Network)

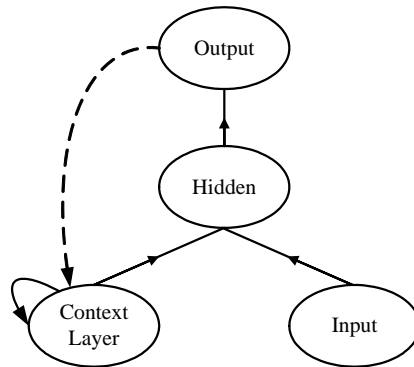

Figure 6.5. Architecture of Jordan's sequential network

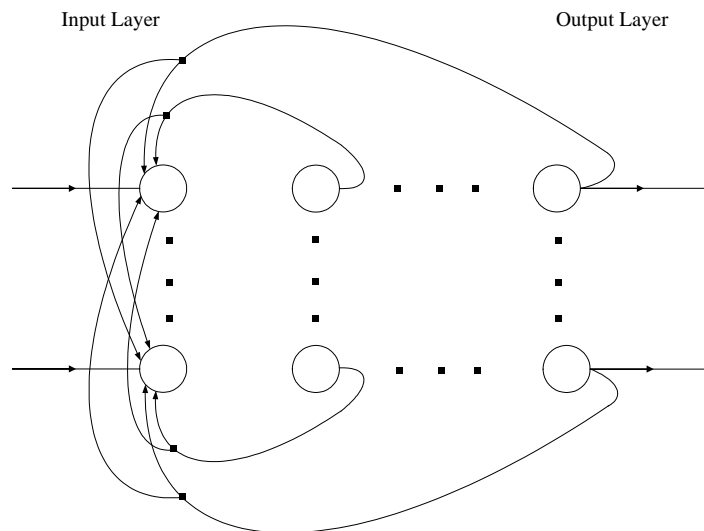

Figure 6.6. Architecture of a fully recurrent network

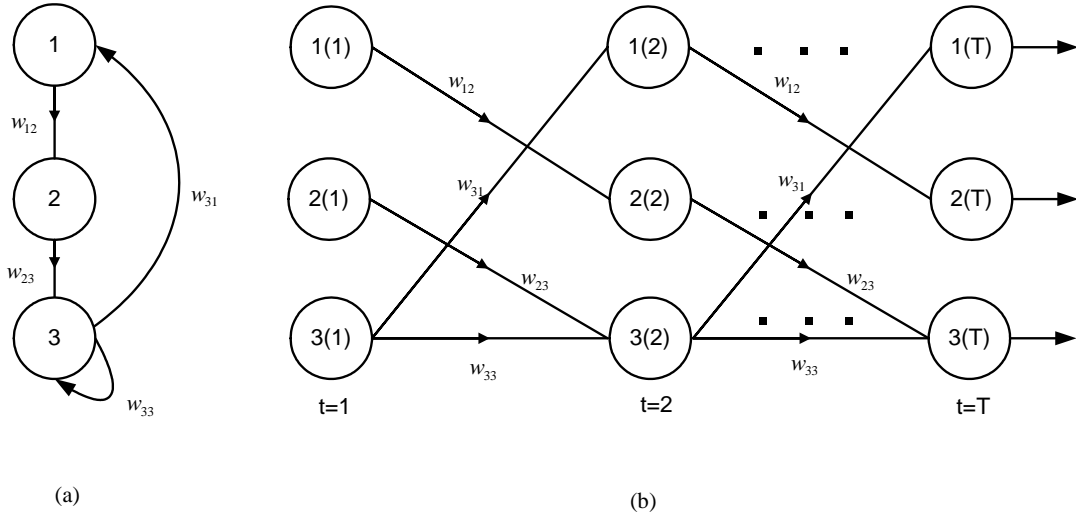

Figure 6.7. Three-unit recurrent network (a) and its feedforward network equivalent (b)

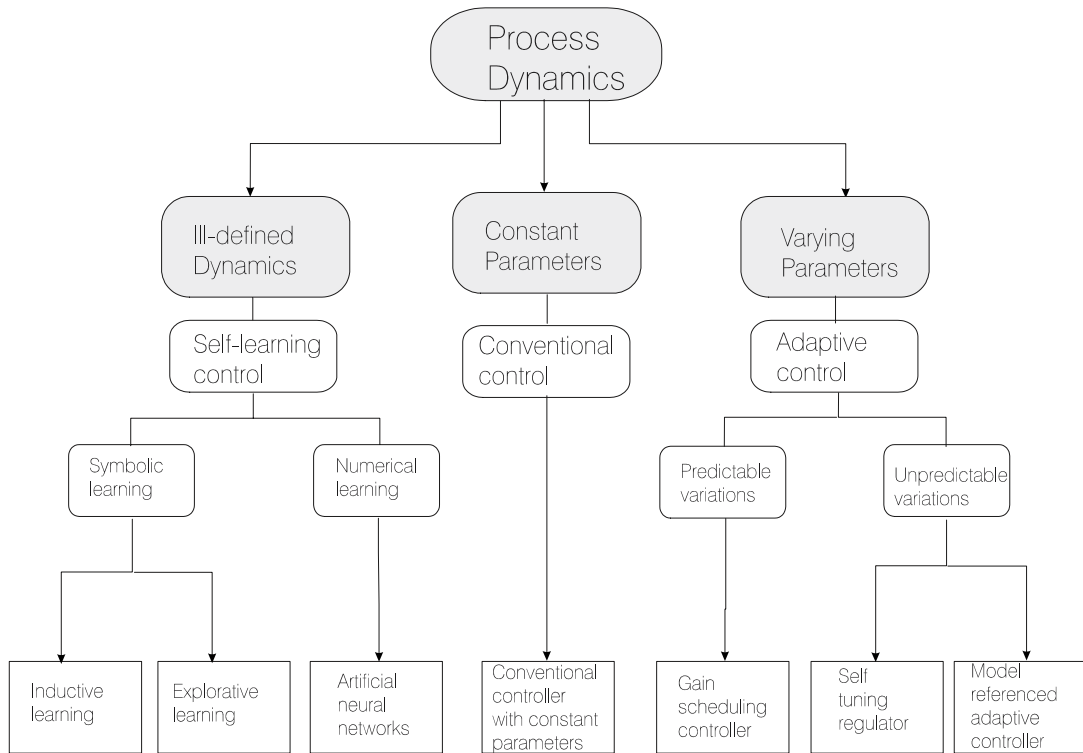

Figure 6.8 Classes of dynamic systems and their appropriate controllers

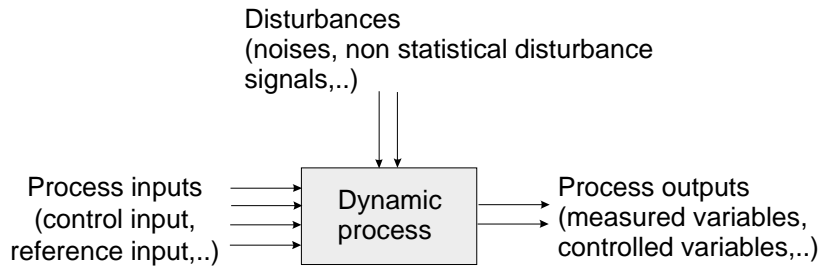

Figure 6.9: Block diagram of a dynamic system

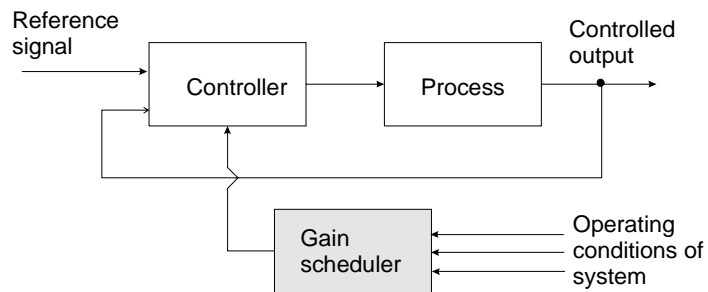

Figure 6.10: Block diagram of the gain scheduling controller

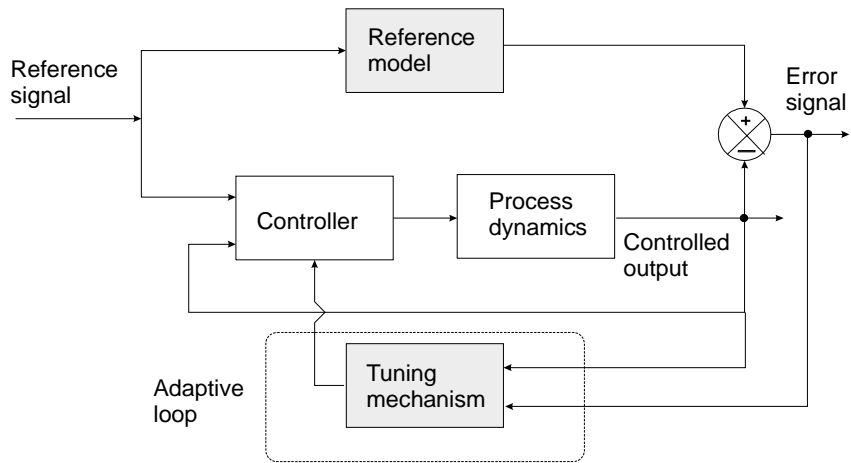

Figure 6.11: Block diagram of a model-referenced adaptive controller

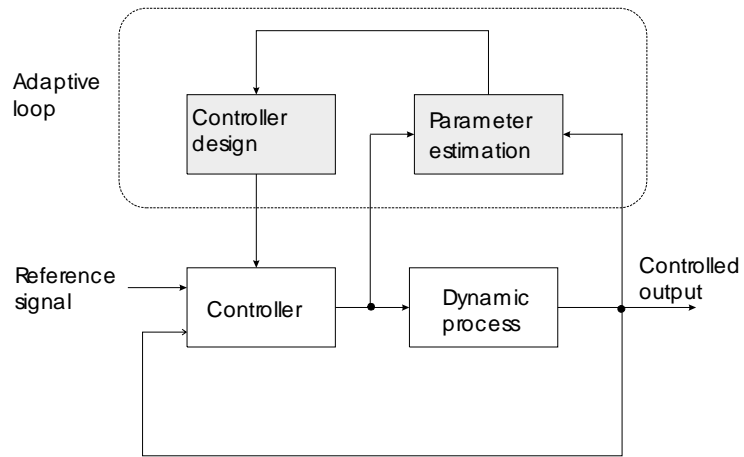

Figure 6.12: Block diagram of the self-tuning regulator

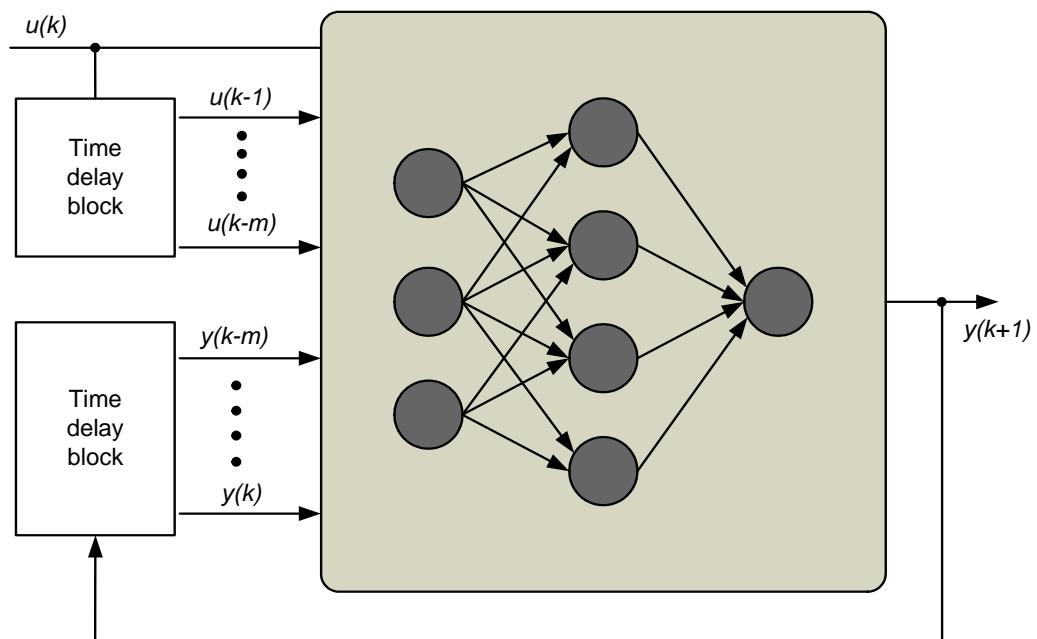

Figure 6.13. Time delayed recurrent neural network

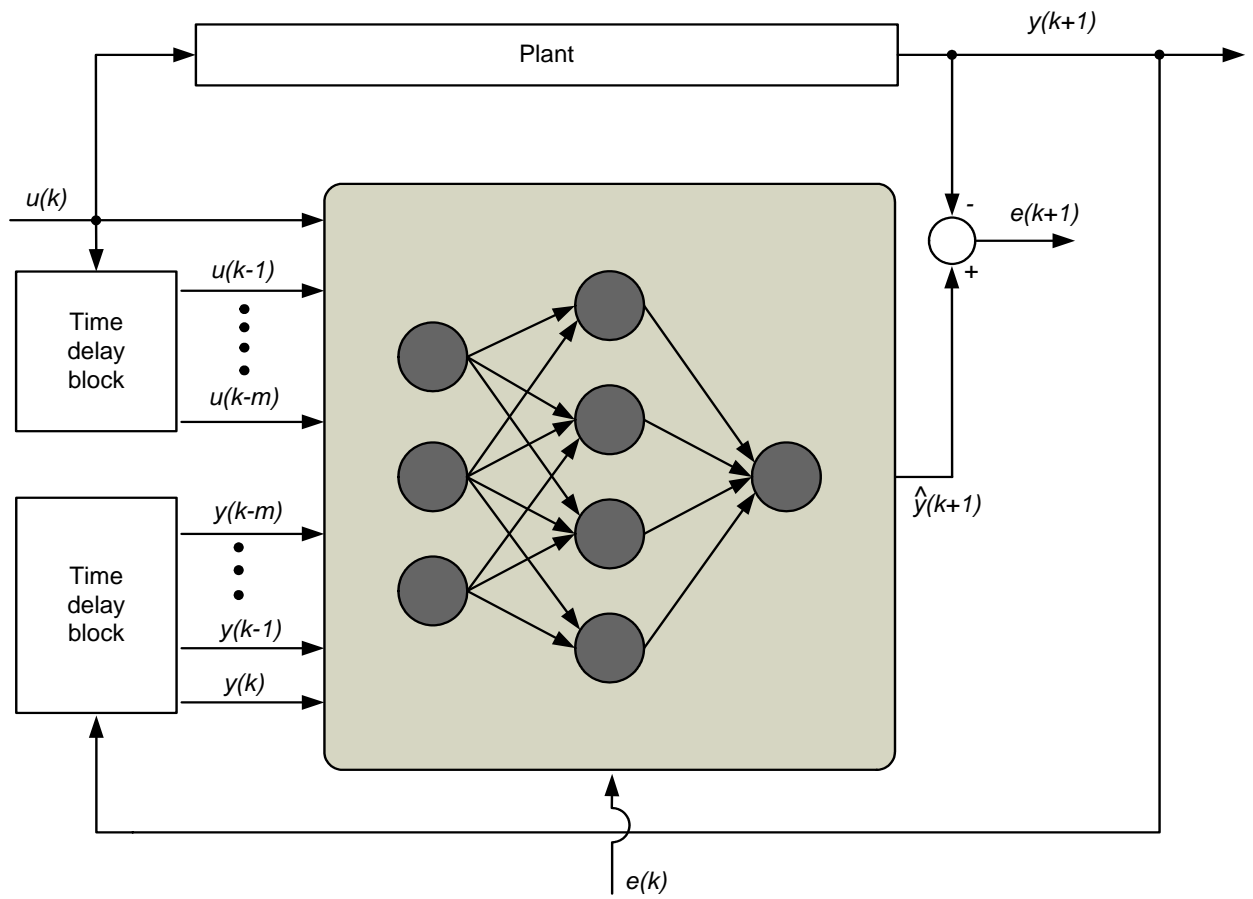

Figure 6.14. Series-parallel scheme for neural identification

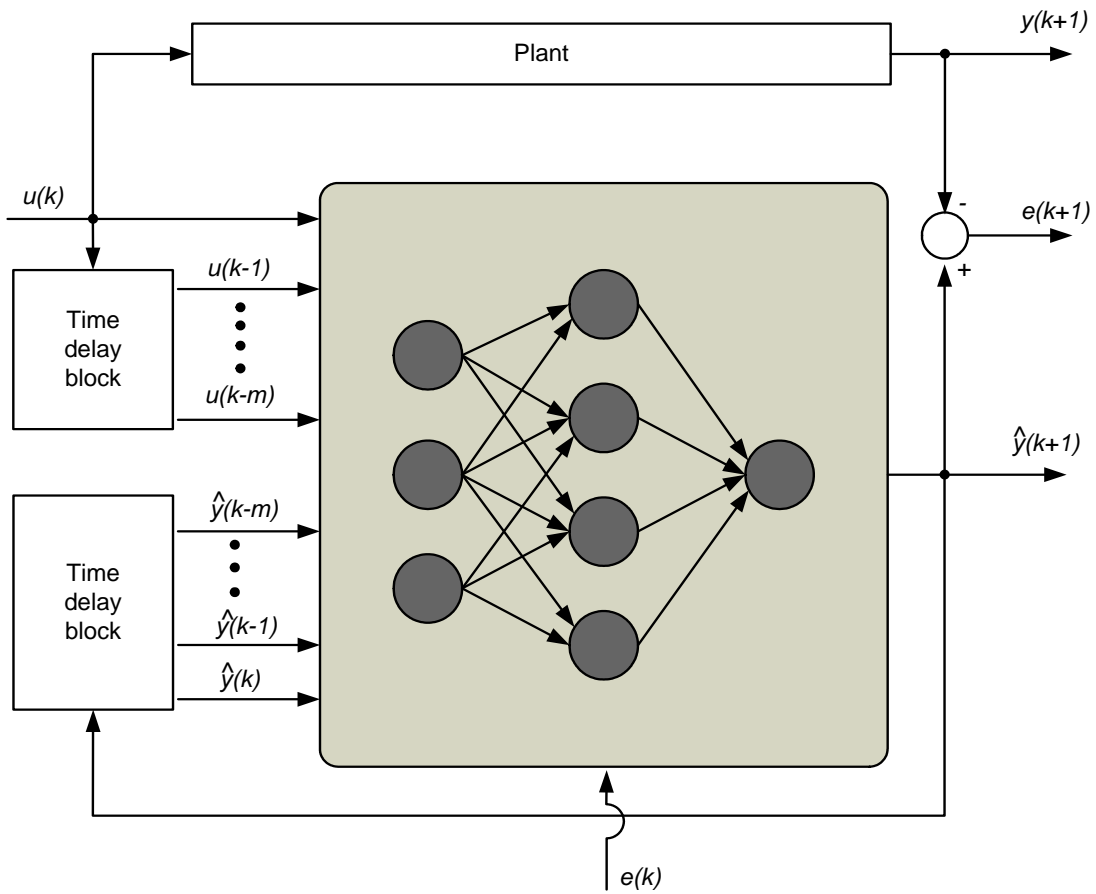

Figure 6.15. Parallel scheme for neural identification

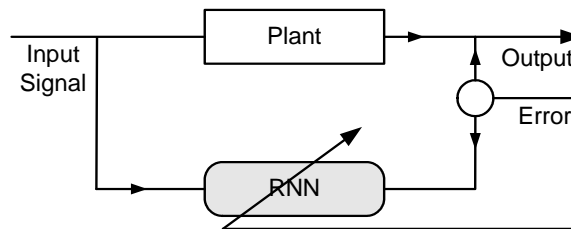

Figure 6.16. System identification using RNN

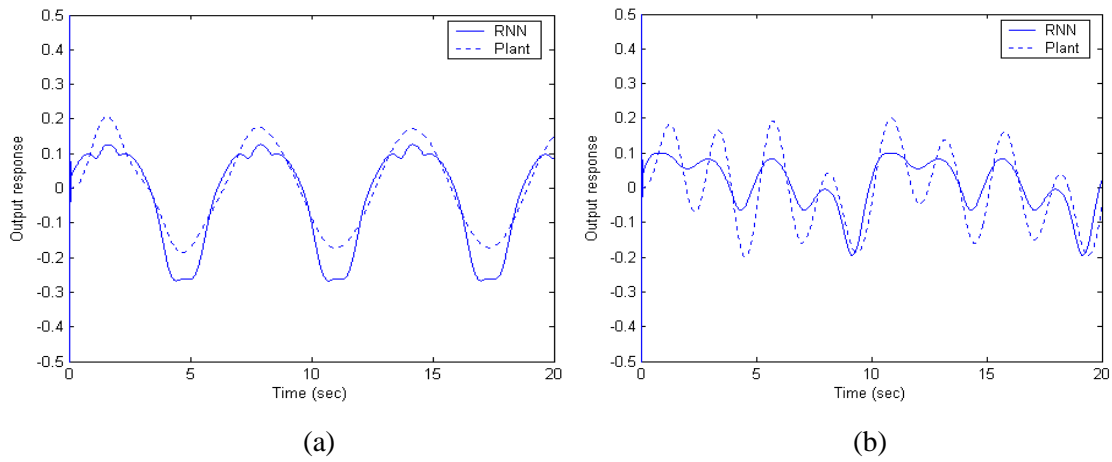

Figure 6.17. (a) Identification results with first set of input, (b) Identification results with second set of input

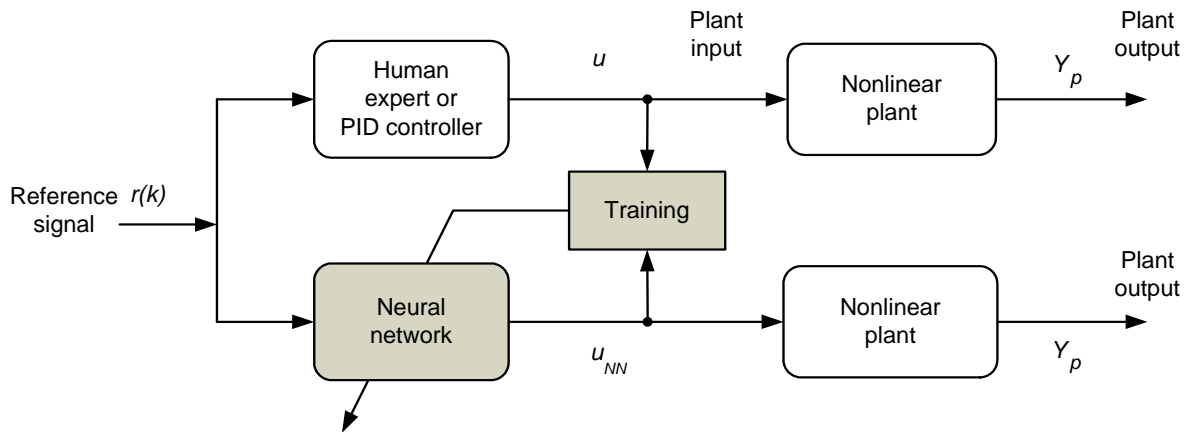

Figure 6.18. Neural network acting as a supervisory controller

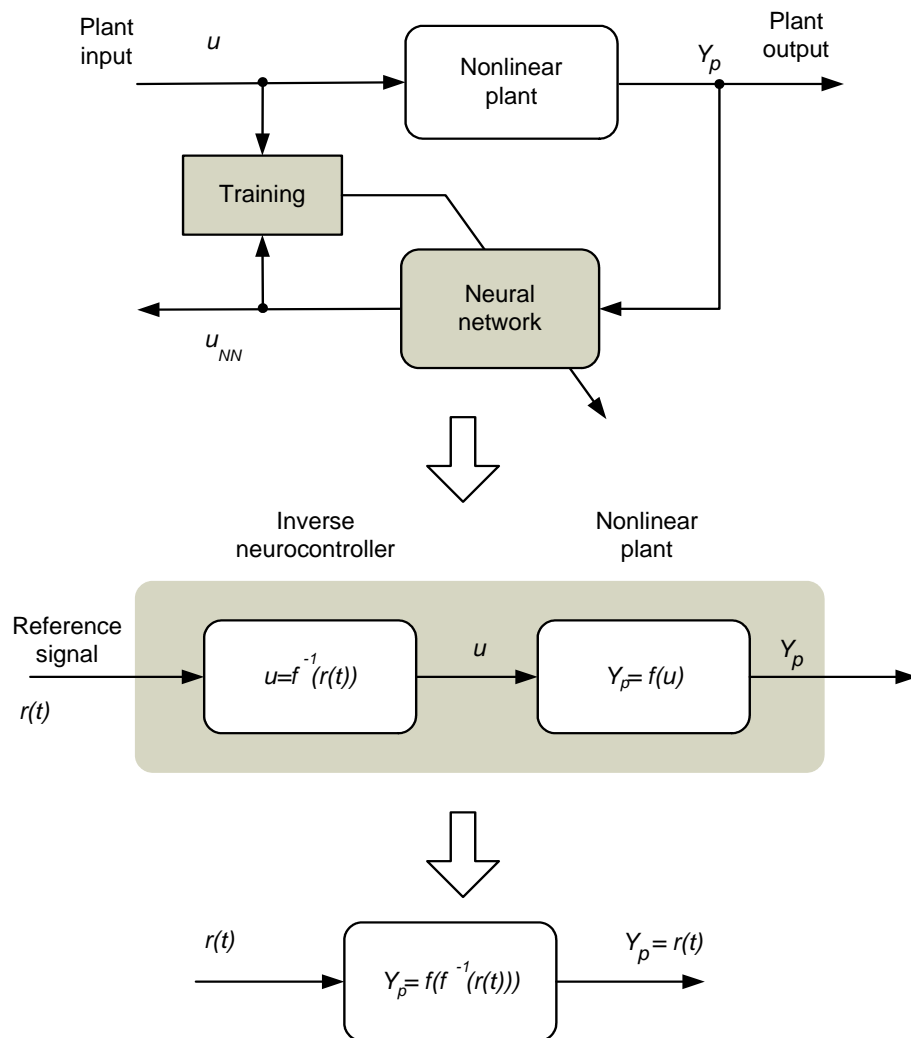

Figure 6.19 Neural network as inverse model based controller

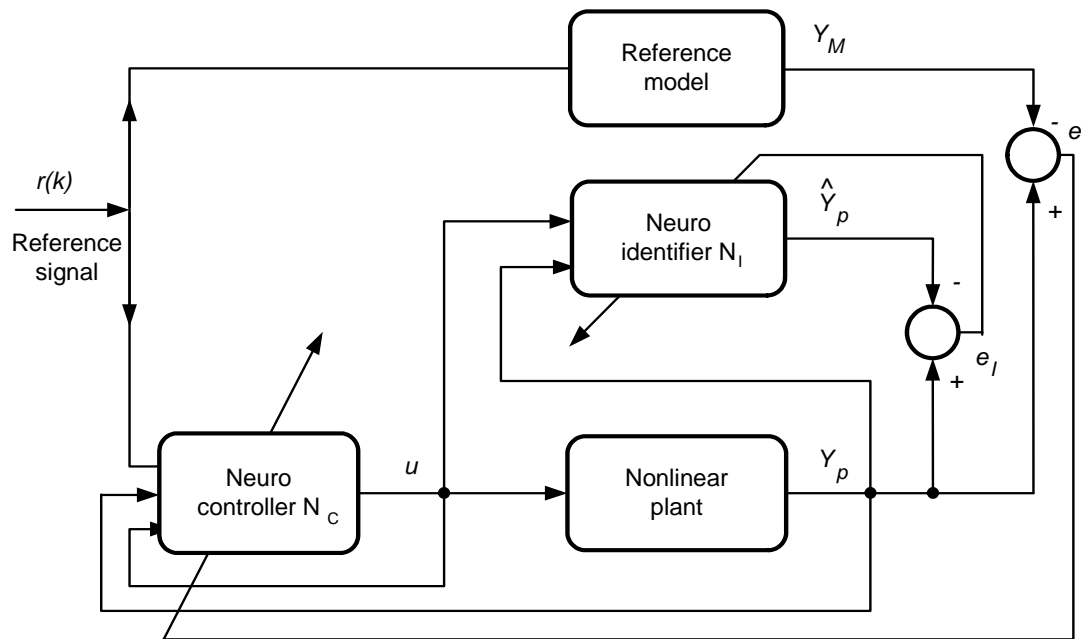

Figure 6.20 Neural network as Neuro Adaptive Controller.

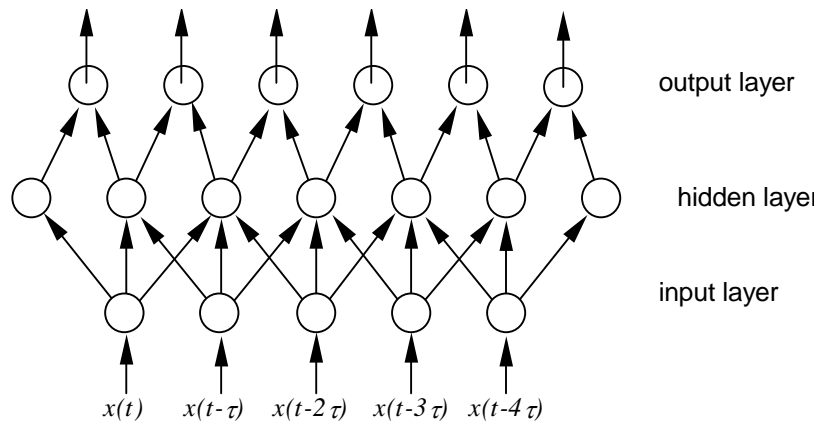

Figure 6.21: Model of single-input time-delay neural network. Inputs are successively delayed by τ units, with hidden layer elements depending on current and two delayed inputs. Outputs depend on two delay units only.

Mackey-Glass Time Series ($\tau=17$)

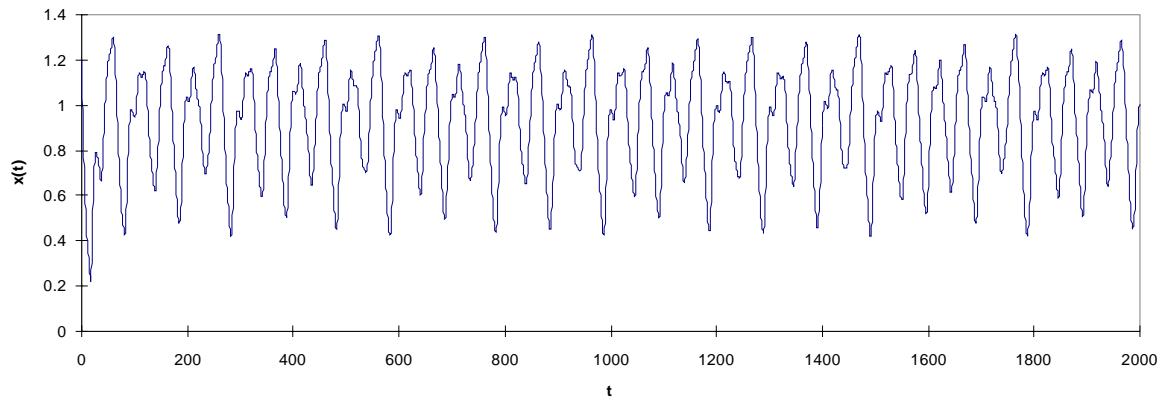

Figure 6.22: Mackey-Glass time series.